

CW/CQ型射频绕线片式电感器

★ 特征与用途

FEATURES AND APPLICATIONS

- 高Q值、高自谐频率
- 体积小、重量轻,适合高密度表面贴装
- 应用于滤波、扼流、阻抗匹配、谐振等电路
- 参照GJB 1864A-2011、Q/XEC 004A-2014、Q/XEC 012A-2014、Q/XEC 029A-2014、Q/XEC 20028A-2014、Q/XEC 055A-2014、Q/XEC 20027A-2014



★ 产品型号

PRODUCT IDENTIFICATION

1008 CW 120 J G P
①—②—③—④—⑤—⑥

- ① 外形尺寸: 长×宽
- ② CW:陶瓷体绕线(常规产品); CQ: 高Q值陶瓷体绕线
- ③ 电感量: 1R2表示1.2nH, 120表示12nH, 121表示120nH, 122表示1200nH
- ④ 电感量偏差: G表示±2%, J表示±5%, K表示±10%, M表示±20%
- ⑤ 焊盘材料: G表示镍镀金
- ⑥ 包装方式: T成盘 P编带

★ 外观尺寸

SHAPE AND DIMENSIONS

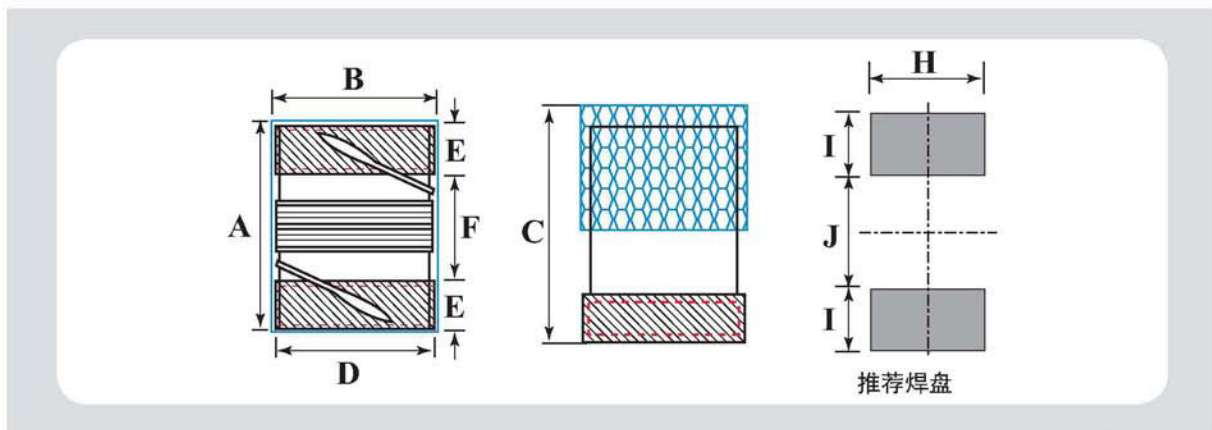

单位: mm

型号	A(Max)	B(Max)	C(Max)	D	E	F	H	I	J	重量 (Max)
0402CW	1.19	0.64	0.66	0.51	0.23	0.56	0.66	0.36	0.46	2mg
0603CW/CQ	1.80	1.24	1.24	0.76	0.33	0.86	1.02	0.64	0.64	10mg
0805CW/CQ	2.29	1.73	1.55	1.27	0.50	1.03	1.78	1.02	0.76	25mg
1008CW/CQ	2.92	2.79	2.29	2.00	0.50	1.43	2.54	1.02	1.27	50mg
1206CW	3.56	2.16	1.52	1.60	0.50	2.20	1.93	1.02	1.78	100mg
1210CW	3.65	2.95	2.70	2.10	0.50	2.03	3.02	1.02	1.78	150mg
1812CW	4.95	3.81	3.60	2.90	0.58	3.25	3.05	1.14	3.00	180mg

注: 未标注尺寸偏差为±0.05mm。

● 0402CW TYPE

型号	电感量		电感量 偏差	品质因素		直流 电阻 Max (Ω)	自谐 频率 Min (MHz)	额定 电流 Max (mA)
	测试频率 (MHz)	标准值 (nH)		测试频率 (MHz)	标准值 Min			
0402CW1R0KGP	250	1.0	K,M	250	13	0.045	12700	1000
0402CW1R2KGP	250	1.2	K,M	250	13	0.060	12000	600
0402CW1R8KGP	250	1.8	K,M	250	13	0.070	11500	800
0402CW1R9KGP	250	1.9	K,M	250	16	0.070	11300	800
0402CW2R0KGP	250	2.0	K,M	250	16	0.070	11100	800
0402CW2R2KGP	250	2.2	K,M	250	18	0.070	10800	760
0402CW2R4KGP	250	2.4	K,M	250	18	0.070	10500	760
0402CW2R7KGP	250	2.7	K,M	250	13	0.120	10400	500
0402CW3R0KGP	250	3.0	K,M	250	20	0.066	7000	650
0402CW3R3KGP	250	3.3	K,M	250	20	0.066	7000	650
0402CW3R6KGP	250	3.6	J,K,M	250	20	0.066	6800	650
0402CW3R9KGP	250	3.9	J,K,M	250	20	0.066	6000	650
0402CW4R3KGP	250	4.3	J,K,M	250	20	0.091	6000	560
0402CW4R7KGP	250	4.7	J,K,M	250	20	0.083	4775	640
0402CW5R1KGP	250	5.1	J,K,M	250	23	0.083	5800	640
0402CW5R6KGP	250	5.6	J,K,M	250	23	0.083	5800	600
0402CW6R2KGP	250	6.2	J,K,M	250	23	0.083	5800	600
0402CW6R8KGP	250	6.8	J,K,M	250	20	0.083	5800	540
0402CW7R3KGP	250	7.3	J,K,M	250	25	0.130	6000	450
0402CW7R5KGP	250	7.5	J,K,M	250	25	0.100	5800	540
0402CW8R2KGP	250	8.2	J,K,M	250	25	0.100	4400	540
0402CW8R7KGP	250	8.7	J,K,M	250	25	0.100	4200	540
0402CW9R0KGP	250	9.0	J,K,M	250	25	0.100	4160	540
0402CW9R5KGP	250	9.5	J,K,M	250	21	0.162	4000	480
0402CW100KGP	250	10	J,K,M	250	21	0.200	3900	350
0402CW110JGP	250	11	G,J,K	250	26	0.120	3680	500
0402CW120JGP	250	12	G,J,K	250	26	0.120	3600	500
0402CW130JGP	250	13	G,J,K	250	26	0.185	3450	440
0402CW150JGP	250	15	G,J,K	250	26	0.170	3280	440
0402CW160JGP	250	16	G,J,K	250	26	0.220	3100	440
0402CW180JGP	250	18	G,J,K	250	26	0.230	3100	380
0402CW190JGP	250	19	G,J,K	250	26	0.200	3040	380
0402CW200JGP	250	20	G,J,K	250	26	0.250	3000	320
0402CW220JGP	250	22	G,J,K	250	26	0.250	2800	320
0402CW230JGP	250	23	G,J,K	250	26	0.250	2720	320
0402CW240JGP	250	24	G,J,K	250	26	0.300	2700	320
0402CW270JGP	250	27	G,J,K	250	26	0.300	2480	320
0402CW300JGP	250	30	G,J,K	250	25	0.300	2350	320

★ 规格特性

SPECIFICATIONS

● 0402CW TYPE

型号	电感量		电感量 偏差	品质因素		直流 电阻 Max (Ω)	自谐 频率 Min (MHz)	额定 电流 Max (mA)
	测试频率 (MHz)	标准值 (nH)		测试频率 (MHz)	标准值 Min			
0402CW330JGP	250	33	G,J,K	250	25	0.350	2350	320
0402CW360JGP	250	36	G,J,K	250	26	0.400	2320	250
0402CW390JGP	250	39	G,J,K	250	25	0.500	2100	160
0402CW400JGP	250	40	G,J,K	250	26	0.550	2240	160
0402CW430JGP	250	43	G,J,K	250	25	0.700	2030	120
0402CW470JGP	250	47	G,J,K	250	20	0.750	2100	120
0402CW510JGP	250	51	G,J,K	250	25	0.820	1750	80
0402CW560JGP	250	56	G,J,K	250	25	0.970	1760	80
0402CW620JGP	250	62	G,J,K	250	25	0.970	1620	80
0402CW680JGP	250	68	G,J,K	250	25	1.120	1620	80
0402CW720JGP	250	72	G,J,K	250	25	1.550	1620	80
0402CW820JGP	250	82	G,J,K	250	25	1.550	1620	80
0402CW101JGP	250	100	G,J,K	250	25	2.600	1620	80

注：表中型号电感量偏差为可生产常规偏差，若用户需订购其它偏差，需按电感量偏差栏代号进行选择。

● 0603CW TYPE

型号	电感量		电感量 偏差	品质因素		直流 电阻 Max (Ω)	自谐 频率 Min (MHz)	额定 电流 Max (mA)
	测试频率 (MHz)	标准值 (nH)		测试频率 (MHz)	标准值 Min			
0603CW1R5KGP	250	1.5	K,M	250	24	0.03	6000	600
0603CW1R6KGP	250	1.6	K,M	250	20	0.05	6000	600
0603CW1R8KGP	250	1.8	K,M	250	10	0.13	6000	700
0603CW2R0KGP	250	2.0	K,M	250	15	0.18	6000	600
0603CW2R2KGP	250	2.2	K,M	250	13	0.25	6000	600
0603CW3R0KGP	250	3.0	K,M	250	20	0.08	6000	600
0603CW3R3KGP	250	3.3	K,M	250	35	0.045	6000	700
0603CW3R6KGP	250	3.6	K,M	250	20	0.063	5900	700
0603CW3R9KGP	250	3.9	K,M	250	22	0.08	6000	700
0603CW4R3KGP	250	4.3	K,M	250	22	0.10	5900	700
0603CW4R7KGP	250	4.7	K,M	250	20	0.116	5800	700
0603CW5R1KGP	250	5.1	K,M	250	20	0.14	5700	700
0603CW5R6KGP	250	5.6	K,M	250	25	0.10	6000	700
0603CW6R0KGP	250	6.0	K,M	250	25	0.13	6000	700
0603CW6R2KGP	250	6.2	K,M	250	25	0.11	5500	700
0603CW6R8KGP	250	6.8	K,M	250	25	0.11	5800	700
0603CW7R5KGP	250	7.5	K,M	250	30	0.12	4800	600
0603CW8R2KGP	250	8.2	K,M	250	30	0.12	5000	700
0603CW9R5KGP	250	9.5	K,M	250	30	0.13	4800	700

● 0603CW TYPE

型号	电感量		电感量 偏差	品质因素		直流 电阻 Max (Ω)	自谐 频率 Min (MHz)	额定 电流 Max (mA)
	测试频率 (MHz)	标准值 (nH)		测试频率 (MHz)	标准值 Min			
0603CW100KGP	250	10	J,K	250	30	0.13	4800	700
0603CW120JGP	250	12	J,K	250	30	0.13	4000	700
0603CW150JGP	250	15	J,K	250	30	0.17	4000	700
0603CW180JGP	250	18	J,K	250	30	0.17	3100	700
0603CW220JGP	250	22	J,K	250	35	0.19	3000	600
0603CW240JGP	250	24	J,K	250	30	0.22	1800	600
0603CW270JGP	250	27	J,K	250	35	0.22	2500	600
0603CW330JGP	250	33	J,K	250	35	0.22	2300	600
0603CW390JGP	250	39	J,K	250	35	0.25	2200	600
0603CW470JGP	200	47	J,K	250	35	0.28	2000	600
0603CW510JGP	200	51	J,K	250	38	0.28	1800	700
0603CW560JGP	200	56	J,K	250	35	0.31	1800	600
0603CW620JGP	200	62	J,K	250	35	0.31	1800	600
0603CW680JGP	200	68	J,K	250	35	0.34	1700	600
0603CW720JGP	150	72	J,K	250	34	0.65	1700	400
0603CW780JGP	150	78	J,K	250	35	0.54	1700	400
0603CW820JGP	150	82	J,K	250	34	0.54	1600	400
0603CW910JGP	150	91	J,K	250	35	0.50	1200	400
0603CW101JGP	150	100	J,K	250	34	0.58	1400	400
0603CW111JGP	150	110	J,K	250	32	0.70	1350	300
0603CW121JGP	150	120	J,K	250	32	0.70	1300	300
0603CW151JGP	150	150	J,K	150	28	0.92	1200	280
0603CW181JGP	100	180	J,K	100	25	1.25	990	240
0603CW201JGP	100	200	J,K	100	25	1.4	800	200
0603CW221JGP	100	220	J,K	100	25	1.5	850	200
0603CW271JGP	100	270	J,K	100	25	1.8	650	170
0603CW331JGP	100	330	J,K	100	24	2.0	500	150
0603CW391JGP	100	390	J,K	100	23	2.1	350	120
0603CW431JGP	100	430	J,K	100	18	2.5	260	50

注：表中型号电感量偏差为可生产常规偏差，若用户需订购其它偏差，需按电感量偏差栏代号进行选择。

★ 规格特性

SPECIFICATIONS

● 0603CQ TYPE

型号	电感量		电感量 偏差	品质因素		直流 电阻 Max (Ω)	自谐 频率 Min (MHz)	额定 电流 Max (mA)
	测试频率 (MHz)	标准值 (nH)		测试频率 (MHz)	标准值 Min			
0603CQ1R8KGP	250	1.8	K,M	250	23	0.055	6000	700
0603CQ2R2KGP	250	2.2	K,M	250	13	0.18	6000	700
0603CQ3R3KGP	250	3.3	K,M	250	32	0.024	6000	1900
0603CQ3R6KGP	250	3.6	K,M	250	40	0.031	6000	1900
0603CQ3R9KGP	250	3.9	K,M	250	35	0.039	6000	1400
0603CQ4R3KGP	250	4.3	K,M	250	30	0.08	6000	900
0603CQ4R7KGP	250	4.7	K,M	250	26	0.1	6000	900
0603CQ5R1KGP	250	5.1	K,M	250	40	0.036	6000	1700
0603CQ5R6KGP	250	5.6	K,M	250	48	0.036	6000	1700
0603CQ6R8KGP	250	6.8	K,M	250	40	0.042	5800	1000
0603CQ7R5KGP	250	7.5	K,M	250	40	0.08	5300	1000
0603CQ8R2KGP	250	8.2	K,M	250	46	0.054	5300	1000
0603CQ9R5KGP	250	9.5	K,M	250	45	0.053	4800	1400
0603CQ100KGP	250	10	J,K	250	45	0.048	4300	1000
0603CQ120JGP	250	12	J,K	250	37	0.088	4000	1100
0603CQ150JGP	250	15	J,K	250	45	0.078	3600	1000
0603CQ180JGP	250	18	J,K	250	40	0.066	3300	900
0603CQ220JGP	250	22	J,K	250	44	0.14	3000	850
0603CQ270JGP	250	27	J,K	250	44	0.15	2700	780
0603CQ330JGP	250	33	J,K	250	45	0.17	2600	700
0603CQ390JGP	250	39	J,K	250	48	0.19	2400	680
0603CQ470JGP	200	47	J,K	250	45	0.25	2200	680
0603CQ510JGP	200	51	J,K	250	49	0.28	2200	630
0603CQ560JGP	200	56	J,K	250	45	0.30	2100	610
0603CQ680JGP	200	68	J,K	250	45	0.30	1800	610
0603CQ720JGP	150	72	J,K	250	46	0.42	1800	520
0603CQ750JGP	150	75	J,K	250	46	0.52	1800	470
0603CQ820JGP	150	82	J,K	250	45	0.46	1700	500
0603CQ910JGP	150	91	J,K	250	45	0.54	1600	440
0603CQ101JGP	150	100	J,K	250	49	0.54	1500	440
0603CQ111JGP	150	110	J,K	250	47	0.58	1500	420
0603CQ121JGP	150	120	J,K	250	47	0.72	1450	400
0603CQ151JGP	150	150	J,K	250	47	0.95	1300	360
0603CQ181JGP	100	180	J,K	250	48	1.25	1200	300
0603CQ201JGP	100	200	J,K	250	47	1.40	1200	280
0603CQ211JGP	100	210	J,K	250	48	1.60	1100	260
0603CQ221JGP	100	220	J,K	250	37	1.80	850	250
0603CQ251JGP	100	250	J,K	250	45	2.00	800	240

★ 规格特性

SPECIFICATIONS

● 0603CQ TYPE

型号	电感量		电感量 偏差	品质因素		直流 电阻 Max (Ω)	自谐 频率 Min (MHz)	额定 电流 Max (mA)
	测试频率 (MHz)	标准值 (nH)		测试频率 (MHz)	标准值 Min			
0603CQ271JGP	100	270	J,K	250	40	2.20	700	220
0603CQ301JGP	100	300	J,K	250	47	2.20	650	220
0603CQ331JGP	100	330	J,K	250	46	2.50	600	180
0603CQ361JGP	100	360	J,K	250	47	2.80	500	170
0603CQ391JGP	100	390	J,K	250	47	2.80	450	170

注：表中型号电感量偏差为可生产常规偏差，若用户需订购其它偏差，需按电感量偏差栏代号进行选择。

● 0805CW TYPE

型号	电感量		电感量 偏差	品质因素		直流 电阻 Max (Ω)	自谐 频率 Min (MHz)	额定 电流 Max (mA)
	测试频率 (MHz)	标准值 (nH)		测试频率 (MHz)	标准值 Min			
0805CW2R2KGP	250	2.2	K,M	1500	40	0.10	6000	500
0805CW2R7KGP	250	2.7	K,M	1500	40	0.10	6000	500
0805CW3R3KGP	250	3.3	K,M	1500	25	0.20	6000	500
0805CW3R9KGP	250	3.9	K,M	1500	30	0.20	6000	300
0805CW4R7KGP	250	4.7	K,M	1500	60	0.04	6000	500
0805CW5R6KGP	250	5.6	K,M	1000	50	0.05	5500	500
0805CW6R8KGP	250	6.8	K,M	1000	40	0.11	5000	500
0805CW7R5KGP	250	7.5	K,M	1000	40	0.14	4400	500
0805CW8R2KGP	250	8.2	K,M	1000	40	0.19	4600	500
0805CW9R1KGP	250	9.1	K,M	1000	40	0.19	4000	500
0805CW100KGP	250	10	J,K	1000	40	0.14	4500	500
0805CW120JGP	250	12	J,K	500	40	0.15	4000	500
0805CW150JGP	250	15	J,K	500	40	0.17	2900	500
0805CW180JGP	250	18	J,K	500	50	0.20	3300	500
0805CW220JGP	250	22	J,K	500	55	0.22	2000	400
0805CW240JGP	250	24	J,K	500	50	0.22	2000	500
0805CW270JGP	250	27	J,K	500	55	0.25	2500	400
0805CW330JGP	250	33	J,K	500	60	0.27	2050	400
0805CW360JGP	250	36	J,K	500	50	0.27	1700	500
0805CW390JGP	250	39	J,K	500	60	0.29	2000	400
0805CW470JGP	200	47	J,K	500	50	0.31	1650	400
0805CW510JGP	200	51	J,K	500	45	0.38	1600	500
0805CW560JGP	200	56	J,K	500	55	0.32	1550	400
0805CW620JGP	200	62	J,K	500	50	0.35	1400	400
0805CW660JGP	200	66	J,K	500	55	0.38	1450	400
0805CW680JGP	200	68	J,K	500	55	0.38	1450	400
0805CW720JGP	200	72	J,K	500	50	0.40	1400	400

★ 规格特性

SPECIFICATIONS

● 0805CW TYPE

型号	电感量		电感量 偏差	品质因素		直流 电阻 Max (Ω)	自谐 频率 Min (MHz)	额定 电流 Max (mA)
	测试频率 (MHz)	标准值 (nH)		测试频率 (MHz)	标准值 Min			
0805CW750JGP	150	75	J,K	500	50	0.40	1300	400
0805CW820JGP	150	82	J,K	500	50	0.42	1300	300
0805CW910JGP	150	91	J,K	500	50	0.48	1200	400
0805CW101JGP	150	100	J,K	500	50	0.46	1200	300
0805CW111JGP	150	110	J,K	500	50	0.50	1100	300
0805CW121JGP	150	120	J,K	250	50	0.51	1100	300
0805CW131JGP	150	130	J,K	250	55	0.50	1200	400
0805CW151JGP	100	150	J,K	250	50	0.56	920	300
0805CW161JGP	100	160	J,K	250	45	0.80	900	300
0805CW181JGP	100	180	J,K	250	50	0.64	870	300
0805CW201JGP	100	200	J,K	250	45	0.64	870	300
0805CW221JGP	100	220	J,K	250	45	1.10	850	300
0805CW271JGP	100	270	J,K	250	38	1.00	650	250
0805CW301JGP	100	300	J,K	250	35	1.50	650	210
0805CW331JGP	100	330	J,K	250	40	1.40	650	210
0805CW361JGP	100	360	J,K	250	35	1.50	560	190
0805CW391JGP	100	390	J,K	250	35	1.50	560	190
0805CW431JGP	50	430	J,K	100	28	1.50	375	150
0805CW471JGP	50	470	J,K	100	33	1.72	375	150
0805CW511JGP	25	510	J,K	50	20	1.80	300	130
0805CW561JGP	25	560	J,K	50	23	1.90	330	130
0805CW621JGP	25	620	J,K	50	23	1.95	280	100
0805CW681JGP	25	680	J,K	50	23	2.05	270	90
0805CW751JGP	25	750	J,K	50	23	2.1	240	80
0805CW821JGP	25	820	J,K	50	23	2.3	250	80
0805CW861JGP	25	860	J,K	50	20	2.4	235	80
0805CW911JGP	25	910	J,K	50	22	2.4	230	80
0805CW102JGP	25	1000	J,K	50	20	2.5	200	50
0805CW122JGP	25	1200	J,K	50	18	3.5	150	50
0805CW152JGP	25	1500	J,K	50	15	3.8	130	50
0805CW182JGP	7.9	1800	J,K	25	15	4.0	90	50
0805CW202JGP	7.9	2000	J,K	25	15	4.3	80	50
0805CW222JGP	7.9	2200	J,K	25	16	4.6	70	40
0805CW272JGP	7.9	2700	J,K	7.9	15	5.0	70	40
0805CW332JGP	7.9	3300	J,K	7.9	10	5.4	80	50

注：表中型号电感量偏差为可生产常规偏差，若用户需订购其它偏差，需按电感量偏差栏代号进行选择。

● 0805CQ TYPE

型号	电感量		电感量 偏差	品质因素		直流 电阻 Max (Ω)	自谐 频率 Min (MHz)	额定 电流 Max (mA)
	测试频率 (MHz)	标准值 (nH)		测试频率 (MHz)	标准值 Min			
0805CQ2R5KGP	250	2.5	J,K,M	1500	80	0.020	6000	1600
0805CQ5R6KGP	250	5.6	J,K,M	1500	98	0.035	6000	1600
0805CQ6R2KGP	250	6.2	J,K,M	1000	88	0.035	4750	1600
0805CQ120JGP	250	12	J,K	1000	80	0.045	3000	1600
0805CQ160JGP	250	16	J,K	500	72	0.060	2950	1500
0805CQ180JGP	250	18	J,K	500	75	0.060	2550	1400
0805CQ200JGP	250	20	J,K	500	70	0.055	2050	1400
0805CQ270JGP	250	27	J,K	500	75	0.070	2000	1300
0805CQ300JGP	250	30	J,K	500	65	0.095	1950	1200
0805CQ390JGP	250	39	J,K	500	65	0.110	1600	1100
0805CQ470JGP	200	47	J,K	500	65	0.095	1400	1200
0805CQ480JGP	200	48	J,K	500	65	0.095	1400	1200
0805CQ510JGP	200	51	J,K	500	65	0.120	1400	1000
0805CQ560JGP	200	56	J,K	500	60	0.160	1300	800
0805CQ680JGP	200	68	J,K	500	60	0.260	1300	800
0805CQ820JGP	150	82	J,K	500	55	0.350	1300	500
0805CQ101JGP	150	100	J,K	500	55	0.360	1100	500
0805CQ181JGP	100	180	J,K	250	50	0.690	875	350
0805CQ271JGP	100	270	J,K	250	45	1.00	650	350
0805CQ331JGP	100	330	J,K	250	45	1.20	600	300
0805CQ391JGP	100	390	J,K	250	45	1.50	560	290

注：表中型号电感量偏差为可生产常规偏差，若用户需订购其它偏差，需按电感量偏差栏代号进行选择。

● 1008CW TYPE

型号	电感量		电感量 偏差	品质因素		直流 电阻 Max (Ω)	自谐 频率 Min (MHz)	额定 电流 Max (mA)
	测试频率 (MHz)	标准值 (nH)		测试频率 (MHz)	标准值 Min			
1008CW3R9KGP	50	3.9	K,M	1500	50	0.10	6000	1000
1008CW4R1KGP	50	4.1	K,M	1500	75	0.05	6000	1000
1008CW4R7KGP	50	4.7	K,M	1500	50	0.11	6000	900
1008CW5R6KGP	50	5.6	K,M	1500	55	0.14	6000	600
1008CW8R2KGP	50	8.2	K,M	1500	60	0.05	5500	900
1008CW100KGP	50	10	K,M	500	50	0.12	4100	900
1008CW120JGP	50	12	K,M	500	50	0.09	3300	900
1008CW150JGP	50	15	K,M	500	50	0.13	2500	900
1008CW180JGP	50	18	K,M	350	50	0.11	2500	900
1008CW200JGP	50	20	K,M	350	50	0.12	2400	900
1008CW220JGP	50	22	J,K	350	55	0.12	2400	900

★ 规格特性

SPECIFICATIONS

● 1008CW TYPE

型号	电感量		电感量 偏差	品质因素		直流 电阻 Max (Ω)	自谐 频率 Min (MHz)	额定 电流 Max (mA)
	测试频率 (MHz)	标准值 (nH)		测试频率 (MHz)	标准值 Min			
1008CW240JGP	50	24	J,K	350	55	0.12	2000	900
1008CW270JGP	50	27	J,K	350	55	0.13	1600	900
1008CW300JGP	50	30	J,K	350	45	0.20	1600	900
1008CW330JGP	50	33	J,K	350	60	0.14	1600	900
1008CW390JGP	50	39	J,K	350	60	0.15	1500	900
1008CW430JGP	50	43	J,K	350	60	0.16	1500	900
1008CW470JGP	50	47	J,K	350	65	0.16	1500	900
1008CW510JGP	50	51	J,K	350	65	0.20	1200	900
1008CW560JGP	50	56	J,K	350	65	0.18	1300	900
1008CW620JGP	50	62	J,K	350	65	0.20	1200	900
1008CW660JGP	50	66	J,K	350	60	0.19	1200	800
1008CW680JGP	50	68	J,K	350	65	0.21	1200	900
1008CW750JGP	50	75	J,K	350	50	0.22	1200	900
1008CW820JGP	50	82	J,K	350	60	0.22	800	900
1008CW910JGP	50	91	J,K	350	55	0.30	800	700
1008CW101JGP	25	100	J,K	350	60	0.56	1000	550
1008CW121JGP	25	120	J,K	350	60	0.63	950	500
1008CW151JGP	25	150	J,K	100	50	0.62	800	480
1008CW181JGP	25	180	J,K	100	50	0.70	750	450
1008CW221JGP	25	220	J,K	100	50	0.80	630	400
1008CW271JGP	25	270	J,K	100	50	0.91	600	400
1008CW331JGP	25	330	J,K	100	50	1.05	530	350
1008CW361JGP	25	360	J,K	100	50	1.06	500	350
1008CW391JGP	25	390	J,K	100	50	1.12	480	350
1008CW431JGP	25	430	J,K	100	50	1.15	450	320
1008CW471JGP	25	470	J,K	100	50	1.19	450	320
1008CW511JGP	25	510	J,K	100	50	1.25	380	320
1008CW561JGP	25	560	J,K	100	50	1.33	390	300
1008CW621JGP	25	620	J,K	100	45	1.40	375	300
1008CW681JGP	25	680	J,K	100	45	1.47	360	280
1008CW751JGP	25	750	J,K	100	45	1.54	360	260
1008CW821JGP	25	820	J,K	100	45	1.61	330	260
1008CW911JGP	25	910	J,K	50	35	1.68	295	260
1008CW102JGP	25	1000	J,K	50	35	1.8	250	250
1008CW122JGP	7.9	1200	J,K	50	35	2.0	200	210
1008CW152JGP	7.9	1500	J,K	50	28	2.3	150	210
1008CW182JGP	7.9	1800	J,K	50	28	2.6	120	200
1008CW222JGP	7.9	2200	J,K	50	28	2.8	100	190

● 1008CW TYPE

型号	电感量		电感量 偏差	品质因素		直流 电阻 Max (Ω)	自谐 频率 Min (MHz)	额定 电流 Max (mA)
	测试频率 (MHz)	标准值 (nH)		测试频率 (MHz)	标准值 Min			
1008CW272JGP	7.9	2700	J,K	25	22	3.2	90	190
1008CW332JGP	7.9	3300	J,K	25	22	3.4	70	180
1008CW392JGP	7.9	3900	J,K	25	20	3.6	60	160
1008CW472JGP	7.9	4700	J,K	25	20	4.0	50	160
1008CW562JGP	7.9	5600	J,K	25	20	5.7	40	140
1008CW682JGP	7.9	6800	J,K	25	20	7.7	40	120
1008CW752JGP	7.9	7500	J,K	25	20	10	30	100
1008CW822JGP	7.9	8200	J,K	25	20	10.7	30	100
1008CW103JGP	7.9	10000	J,K	7.9	20	8.5	40	100

注：表中型号电感量偏差为可生产常规偏差，若用户需订购其它偏差，需按电感量偏差栏代号进行选择。

● 1008CQ TYPE

型号	电感量		电感量 偏差	品质因素		直流 电阻 Max (Ω)	自谐 频率 Min (MHz)	额定 电流 Max (mA)
	测试频率 (MHz)	标准值 (nH)		测试频率 (MHz)	标准值 Min			
1008CQ4R1KGP	50	4.1	J,K	1500	75	0.05	6000	1600
1008CQ100KGP	50	10	J,K	500	60	0.06	3600	1600
1008CQ120JGP	50	12	J,K	500	70	0.06	2800	1500
1008CQ180JGP	50	18	J,K	350	62	0.07	2700	1400
1008CQ220JGP	50	22	J,K	350	62	0.07	2050	1400
1008CQ330JGP	50	33	J,K	350	75	0.09	1700	1300
1008CQ360JGP	50	36	J,K	350	65	0.09	1400	1300
1008CQ390JGP	50	39	J,K	350	75	0.09	1300	1300
1008CQ470JGP	50	47	J,K	350	75	0.12	1450	1200
1008CQ560JGP	50	56	J,K	350	75	0.12	1230	1200
1008CQ680JGP	50	68	J,K	350	80	0.13	1150	1100
1008CQ820JGP	50	82	J,K	350	80	0.16	1060	1100
1008CQ101JGP	50	100	J,K	350	62	0.16	820	1000
1008CQ121JGP	50	120	J,K	350	62	0.17	800	1000
1008CQ151JGP	50	150	J,K	350	60	0.21	750	950
1008CQ181JGP	25	180	J,K	100	60	0.40	750	800
1008CQ221JGP	25	220	J,K	100	55	0.50	630	700
1008CQ271JGP	25	270	J,K	100	55	0.60	600	700

注：表中型号电感量偏差为可生产常规偏差，若用户需订购其它偏差，需按电感量偏差栏代号进行选择。

★ 规格特性

SPECIFICATIONS

● 1206CW TYPE

型号	电感量		电感量 偏差	品质因素		直流 电阻 Max (Ω)	自谐 频率 Min (MHz)	额定 电流 Max (mA)
	测试频率 (MHz)	标准值 (nH)		测试频率 (MHz)	标准值 Min			
1206CW3R3KGP	100	3.3	K,M	300	20	0.07	6200	800
1206CW4R7KGP	100	4.7	K,M	300	20	0.07	5500	700
1206CW6R8KGP	100	6.8	K,M	300	30	0.07	5500	800
1206CW100KGP	100	10	K,M	300	40	0.09	4000	800
1206CW120JGP	100	12	K,M	300	40	0.09	3200	800
1206CW150JGP	100	15	K,M	300	40	0.12	3200	800
1206CW180JGP	100	18	J,K	300	45	0.12	2800	800
1206CW220JGP	100	22	J,K	300	50	0.12	2200	800
1206CW270JGP	100	27	J,K	300	50	0.12	1800	800
1206CW330JGP	100	33	J,K	300	50	0.12	1800	800
1206CW390JGP	100	39	J,K	300	50	0.12	1800	800
1206CW470JGP	100	47	J,K	300	50	0.13	1500	800
1206CW560JGP	100	56	J,K	300	55	0.14	1450	800
1206CW620JGP	100	62	J,K	300	55	0.20	1300	800
1206CW680JGP	100	68	J,K	300	55	0.26	1200	700
1206CW750JGP	100	75	J,K	300	55	0.26	1200	700
1206CW820JGP	100	82	J,K	300	55	0.21	1200	700
1206CW101JGP	100	100	J,K	300	55	0.30	1100	700
1206CW121JGP	100	120	J,K	300	60	0.30	1100	700
1206CW151JGP	100	150	J,K	300	55	0.31	950	650
1206CW181JGP	50	180	J,K	300	60	0.43	900	600
1206CW221JGP	50	220	J,K	300	60	0.56	760	570
1206CW241JGP	50	240	J,K	300	50	0.56	750	500
1206CW271JGP	50	270	J,K	300	50	0.56	730	450
1206CW301JGP	50	300	J,K	150	45	0.65	630	420
1206CW331JGP	50	330	J,K	150	45	0.70	650	420
1206CW391JGP	50	390	J,K	150	45	0.80	600	390
1206CW471JGP	50	470	J,K	150	45	1.30	550	350
1206CW561JGP	35	560	J,K	150	45	1.34	470	320
1206CW601JGP	35	600	J,K	150	45	1.50	450	270
1206CW681JGP	35	680	J,K	150	45	1.58	450	270
1206CW751JGP	35	750	J,K	150	40	1.75	500	250
1206CW821JGP	35	820	J,K	150	45	1.82	420	250
1206CW102JGP	35	1000	J,K	150	45	2.80	400	200
1206CW122JGP	35	1200	J,K	150	45	3.20	380	150

注：表中型号电感量偏差为可生产常规偏差，若用户需订购其它偏差，需按电感量偏差栏代号进行选择。

● 1210CW TYPE

型号	电感量		电感量 偏差	品质因素		直流 电阻 Max (Ω)	自谐 频率 Min (MHz)	额定 电流 Max (mA)
	测试频率 (MHz)	标准值 (nH)		测试频率 (MHz)	标准值 Min			
1210CW3R9KGP	100	3.9	K,M	300	30	0.05	6000	900
1210CW4R7KGP	100	4.7	K,M	300	30	0.065	5800	900
1210CW8R2KGP	100	8.2	K,M	300	30	0.07	5500	900
1210CW100KGP	100	10	J,K	300	40	0.08	4000	900
1210CW120JGP	100	12	J,K	300	40	0.08	3200	900
1210CW150JGP	100	15	J,K	300	40	0.10	3200	900
1210CW180JGP	100	18	J,K	300	50	0.10	2800	900
1210CW220JGP	100	22	J,K	300	50	0.10	2200	900
1210CW270JGP	100	27	J,K	300	50	0.11	1800	900
1210CW330JGP	100	33	J,K	300	55	0.11	1800	900
1210CW390JGP	100	39	J,K	300	55	0.12	1500	900
1210CW430JGP	100	43	J,K	300	55	0.12	1500	900
1210CW470JGP	100	47	J,K	300	55	0.13	1500	900
1210CW560JGP	100	56	J,K	300	55	0.14	1450	900
1210CW680JGP	100	68	J,K	300	55	0.15	1200	850
1210CW820JGP	100	82	J,K	300	55	0.20	1000	750
1210CW101JGP	100	100	J,K	300	55	0.20	900	700
1210CW121JGP	100	120	J,K	300	60	0.25	800	650
1210CW151JGP	100	150	J,K	300	60	0.25	700	600
1210CW181JGP	50	180	J,K	300	60	0.30	650	550
1210CW221JGP	50	220	J,K	300	60	0.40	650	500
1210CW271JGP	50	270	J,K	300	40	0.40	580	500
1210CW331JGP	50	330	J,K	150	45	0.58	580	450
1210CW391JGP	50	390	J,K	150	45	0.58	510	450
1210CW471JGP	50	470	J,K	150	45	0.80	480	380
1210CW561JGP	35	560	J,K	150	45	1.10	420	320
1210CW681JGP	35	680	J,K	150	45	1.20	400	300
1210CW821JGP	35	820	J,K	150	45	1.82	370	250
1210CW102JGP	35	1000	J,K	150	45	1.85	340	250
1210CW122JGP	35	1200	J,K	150	35	1.87	220	250
1210CW152JGP	7.9	1500	J,K	50	20	1.95	160	230
1210CW182JGP	7.9	1800	J,K	50	30	2.25	160	220
1210CW222JGP	7.9	2200	J,K	50	25	2.41	130	200
1210CW272JGP	7.9	2700	J,K	25	25	2.85	110	190
1210CW302JGP	7.9	3000	J,K	25	20	3.12	110	180
1210CW332JGP	7.9	3300	J,K	25	20	3.40	100	170
1210CW392JGP	7.9	3900	J,K	25	20	3.60	60	170
1210CW472JGP	7.9	4700	J,K	25	20	4.00	60	160
1210CW562JGP	7.9	5600	J,K	25	15	5.00	50	150
1210CW682JGP	7.9	6800	J,K	7.9	15	8.00	40	120
1210CW742JGP	7.9	7400	J,K	7.9	15	8.50	40	110
1210CW862JGP	7.9	8600	J,K	7.9	15	9.00	40	100

注：表中型号电感量偏差为可生产常规偏差，若用户需订购其它偏差，需按电感量偏差栏代号进行选择。

★ 规格特性

SPECIFICATIONS

● 1812CW TYPE

型号	电感量		电感量 偏差	品质因素		直流 电阻 Max (Ω)	自谐 频率 Min (MHz)	额定 电流 Max (mA)
	测试频率 (MHz)	标准值 (nH)		测试频率 (MHz)	标准值 Min			
1812CW102JGP	7.9	1000	J,K	50	60	1.2	250	350
1812CW122JGP	7.9	1200	J,K	50	60	1.2	230	350
1812CW152JGP	7.9	1500	J,K	50	60	1.6	210	300
1812CW182JGP	7.9	1800	J,K	50	55	2.0	150	270
1812CW222JGP	7.9	2200	J,K	50	55	2.2	150	260
1812CW272JGP	7.9	2700	J,K	50	55	3.2	150	210
1812CW332JGP	7.9	3300	J,K	50	55	3.8	130	200
1812CW392JGP	7.9	3900	J,K	50	55	5.0	120	170
1812CW472JGP	7.9	4700	J,K	50	55	5.4	90	165
1812CW562JGP	7.9	5600	J,K	50	45	5.7	90	160
1812CW682JGP	7.9	6800	J,K	50	30	6.6	80	150
1812CW822JGP	7.9	8200	J,K	50	20	7.0	70	145
1812CW103JGP	7.9	10000	J,K	50	15	7.7	60	135
1812CW123JGP	2.5	12000	J,K	10	30	8.7	50	130
1812CW153JGP	2.5	15000	J,K	10	30	9.6	30	125
1812CW183JGP	2.5	18000	J,K	10	25	10.5	30	115
1812CW223JGP	2.5	22000	J,K	10	25	11.5	20	110
1812CW273JGP	2.5	27000	J,K	10	25	12.5	20	110
1812CW333JGP	2.5	33000	J,K	10	10	13.5	10	100

注：表中型号电感量偏差为可生产常规偏差，若用户需订购其它偏差，需按电感量偏差栏代号进行选择。

★ 电气特性

TYPICAL ELECTRICAL CHARACTERISTICS

● 0402CW TYPE

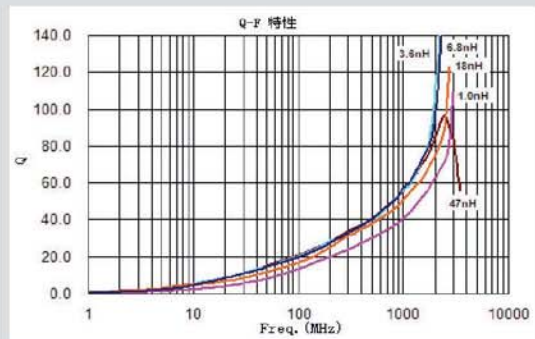
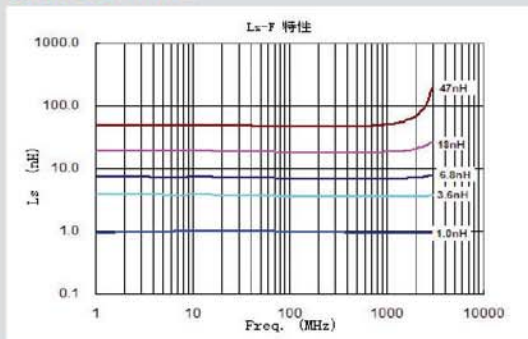

● 0603CW TYPE

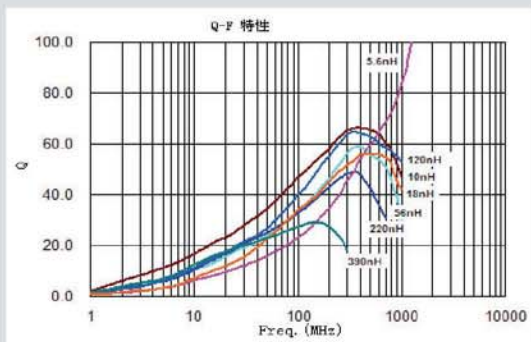
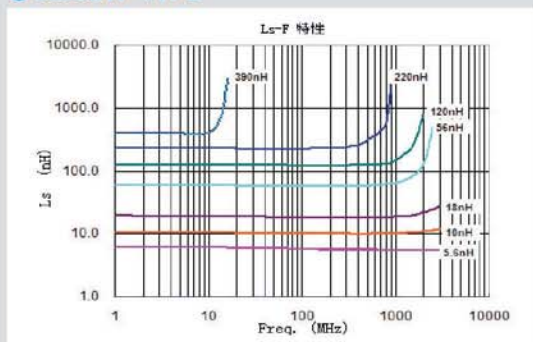

● 0603CQ TYPE

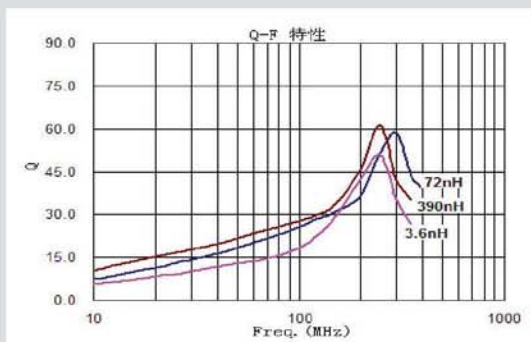
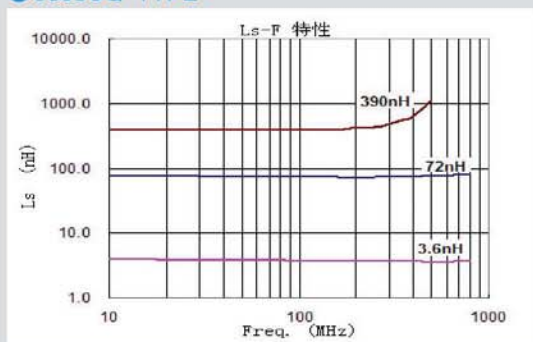

● 0805CW TYPE

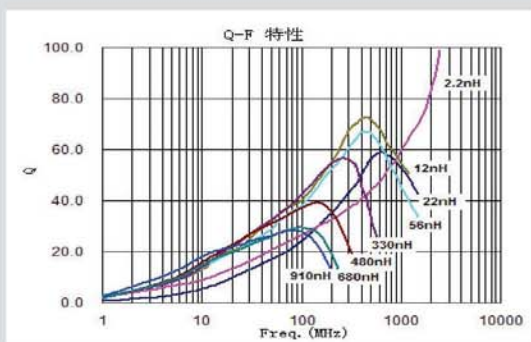
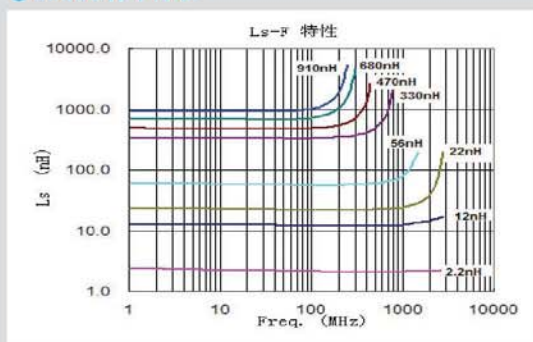

● 0805CQ TYPE

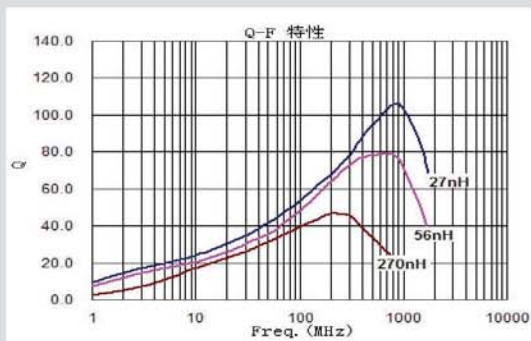
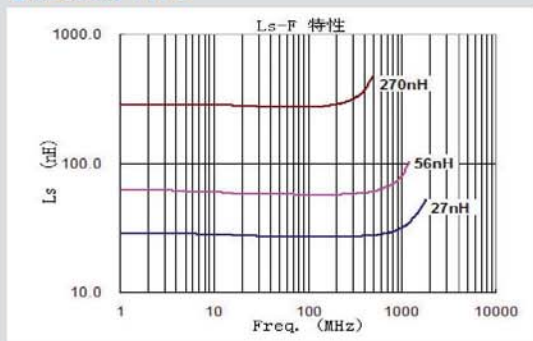

★ 电气特性

TYPICAL ELECTRICAL CHARACTERISTICS

● 1008CW TYPE

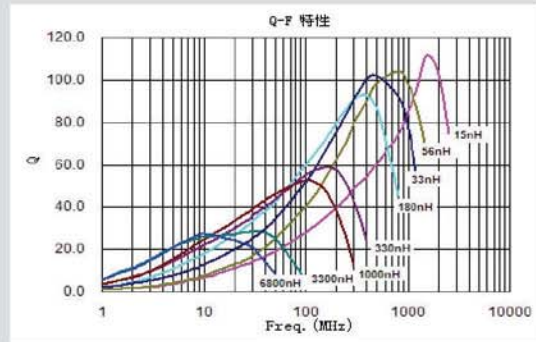
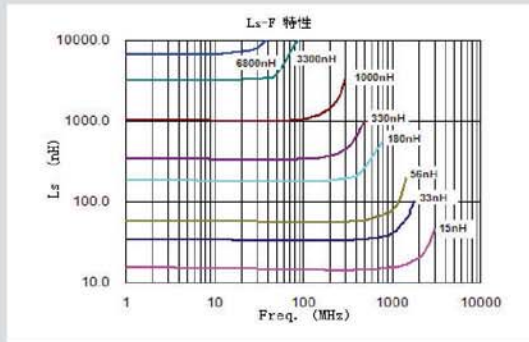

● 1206CW TYPE

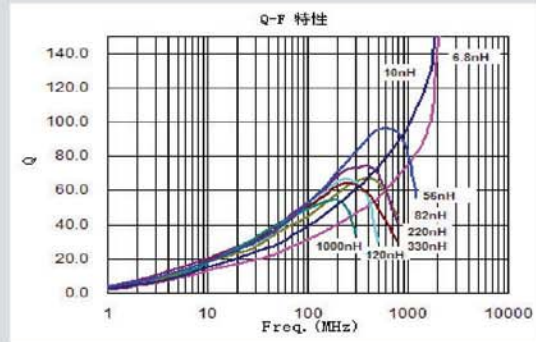
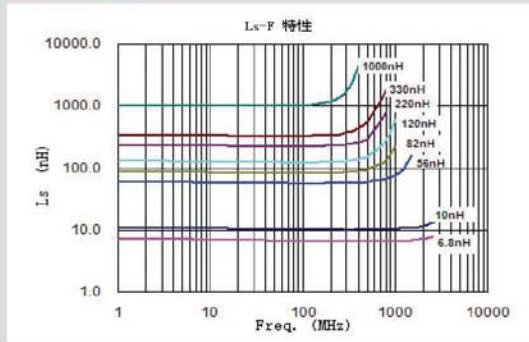

● 1210CW TYPE

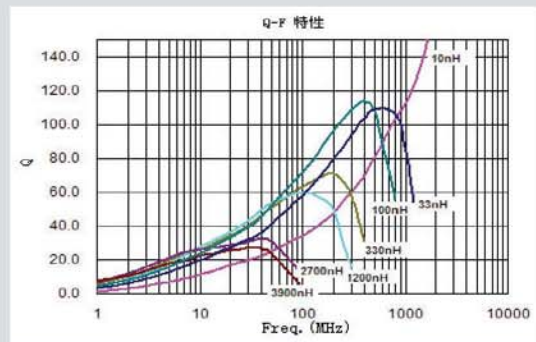
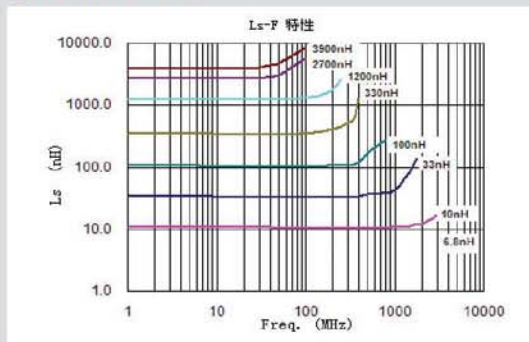

● 1812CW TYPE

